

A/C Recovery, Recycling and Recharge Machine



MAX2

Operating and Service Manual



Safety warning	3	Current Fluid	19	Weight Calibrations.	27
Technical Specifications	4	Statics	19	Pressure Calibrations ...	28
Vehicle Air Condition System	5	Setting	20	Vacuum Calibrations....	28
Components.....	6	Setting	20	Oil Calibrations	30
Control Panel	7	Date/Time	20	Fac.Cal.reset.....	30
Setup	8	Service name	21	Hose Flush	31
Rec. from vehicle	9	Hose	21	Troubleshooting.....	32
Charge vehicle.....	11	Dil-Language	22	Warranty	33
Vacuum time	12	Filling port	22	Warranty Terms.....	33
Leak control.....	13	Service	23	Warranty Certificate ...	35
Refrigerant.....	14	Service	23	Suggestions	36
Filling oil.....	14	Vacuum Pump	24	About Us.....	37
Database	15	Dryer Filter.....	25	Muniments.....	38
Rec from New Tube	17	Software Update	26		
Taskbar.....	18	Valve Test	26		

SAFETY WARNINGS

- ❖ Read this manual carefully and understand all the procedures outlines in this manual before operating the unit. Failure to follow these procedures could result in personal injury or property damage.
- ❖ Allow only qualified personnel to operate this unit. The operator must have basic knowledge of air conditioning and refrigeration systems, including potential hazards associated with the handling of refrigerants and systems under high pressure.
- ❖ Always wear safety goggles and appropriate protective clothing. Avoid contact of liquid refrigerant with the eyes and prolonged skin exposure.
- ❖ Pressurized tank contains liquid refrigerant.
- ❖ Never fill the refrigerant tank to more than 80% of its maximum capacity.
- ❖ Hoses may contain refrigerant under pressure.
- ❖ Make sure to use a properly grounded AC outlet.
- ❖ Do not operate the unit with a damaged cord or plug. Extension cords should not be used unless absolutely necessary.
- ❖ Disconnect unit from power supply before removing any protective cover.
- ❖ Do not expose the unit to wet environment.
- ❖ Only use the correct refrigerants.
- ❖ Avoid breathing in refrigerant vapors. Use only in well ventilated areas.
- ❖ The unit must be transported in a vertical position.
- ❖ The refrigerant scale must be fixed in place before transport.

Model.....	EKM MAX 2
Refrigerant Types.....	R134a & R1234yf
Power Supply	220 V \pm 10% / 50Hz
Display.....	4.3" HMI TFT touch pad LCD screen
Storage Tank Capacity	25 kg
Scale Resolution.....	\pm 5 gr
Compressor.....	1/3 HP 12 cc hermetic
Vacuum Pump.....	6 m ³ /hour
Recovery Rate	450 gr/min maximum
Filter Capacity	150 kg
Operating	8°C to 49°C
Low Pressure Gauge	15 bar
High Pressure Gauge	30 bar
Hose Length.....	180 cm (Optional 250 cm & 300 cm)
Dimensions.....	45 cm x 110 cm x 55 cm
Weight.....	97 kg

VEHICLE AIR CONDITION SYSTEM

COMPRESSOR: It increase pressure of refrigerant. Meanwhile refrigerant temperature increase too.

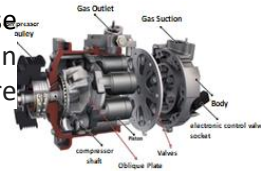

DRYER FILTER: The refrigerant which coming from radiator is dried by the filter. Allows to pass liquid refrigerant through it and also Works a refrigerant tank in the system.

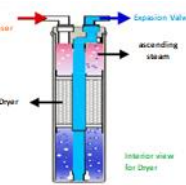

EVAPORATOR: Evaporator is a device in a process used to turn the refrigerant form liquid phase to a vapor. The liquid is evaporated, or vaporized, into a gas form of the targeted substance in that process.



CONDENSER: Role of this unit transition refrigerant to liquid state from gaseous state



EXPANSION VALVE: Expansion valve is a component in a refrigeration and air conditioning systems that controls the amount of refrigerant released into the evaporator there by controlling superheat.

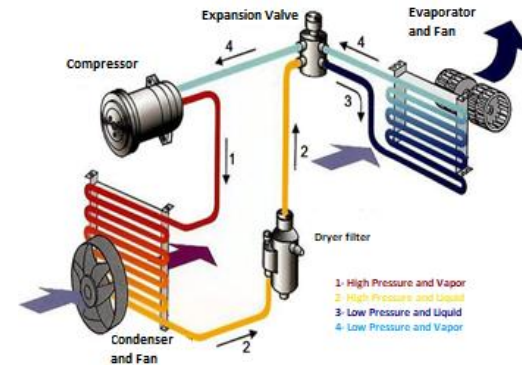
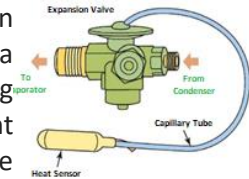

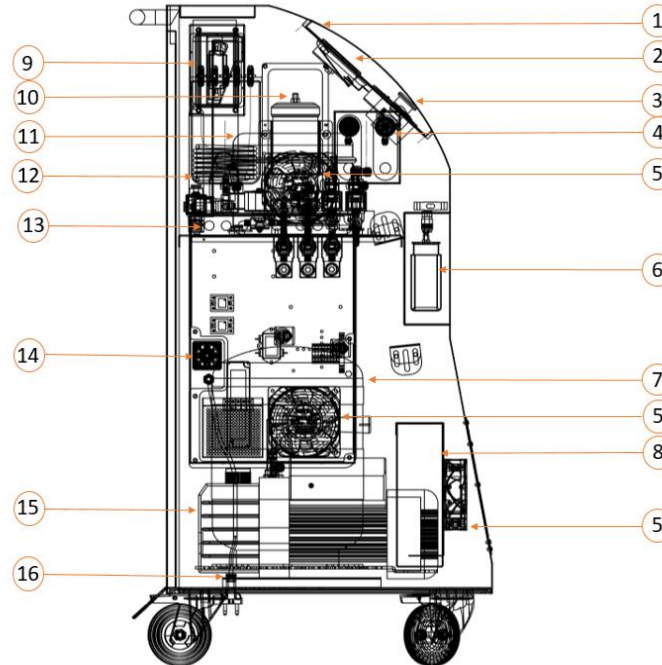

1	Metal Case	5	Fans	9	Gas analyse mode	13	Block
2	H.P and L.P gauges	6	Oil bottles	10	Dryer Filtre	14	On/Off Button
3	Emergency Stop button	7	Gas Tank	11	compressor	15	Vacuum Pump
4	Quick couples	8	condenser	12	Oil seperator	16	Load Cell

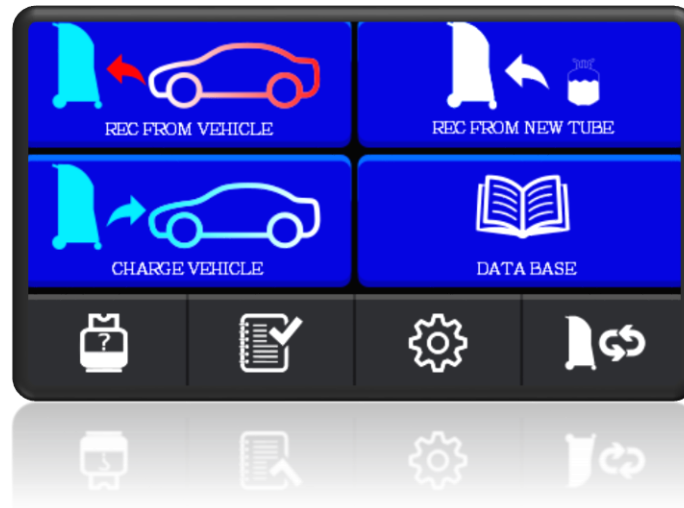

Open the box and take out accessories. Box contents:

- ❖ EKM MAX 2 Unit
- ❖ Low pressure(Blue) and high pressure (Red) vehicle quick couplers
- ❖ User manual and warranty certificate

Before first using:

1. Place the unit on a flat surface.
2. Connect quick coupler valves to the service hoses (DO NOT OVERTIGHTEN).
3. Remove aluminum foil from the vacuum pump and install oil filler cap.
4. Remove fixing bolt located under the unit.
5. Plug the power cable into a grounded power outlet.
6. Turn on the power switch.
7. Perform a vacuum calibration (page 29).

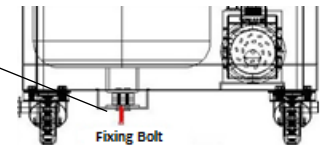

WARNING: The scales are calibrated at the factory. There is no need to calibrate again.

REC FROM VEHICLE

The device draws gas from the air conditioning system of the vehicle, separates it from oil and particles, trap the passed acid and moisture through by the filter, purifies it and transfers it to its own tank.

1. Connect service hoses to vehicle and open adapters.
2. Select REC FROM VEHICLE.
3. device will start recovering refrigerant from vehicle.
4. USED OIL DESCHARGE PLEASE WAIT will display.
5. At the end of process COMPLETED will display.

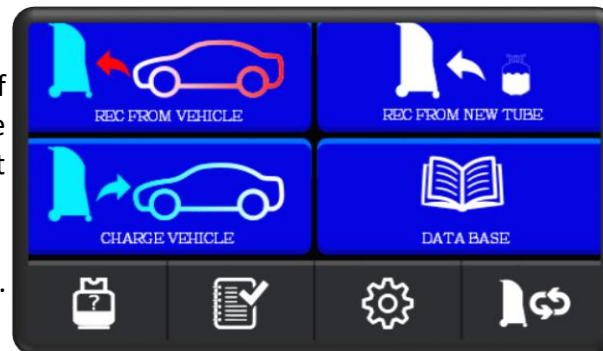

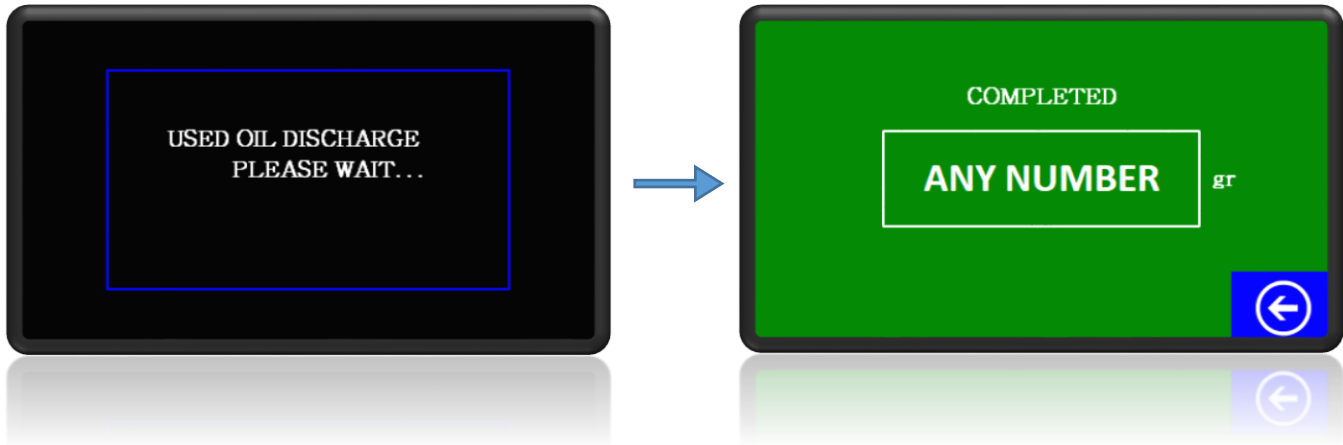

WARNING:

- Some refrigerant will remain in the compressor, hoses or heat exchanger. The amount is dependant on the ambient temperature and last operation performed.
- If you operate the vehicle until reaches to the normal operating temperature before recovering, the gas in the air-conditioning system will heat up and the duration of gas extraction from the car will be shortened. The vehicle A/C must be off.

CHARGE VEHICLE

Uses to charge vehicle A/C system with refrigerant.
Connect the exposed end of the service hoses to the vehicle and turn the quick couples on.

This process will done manually.

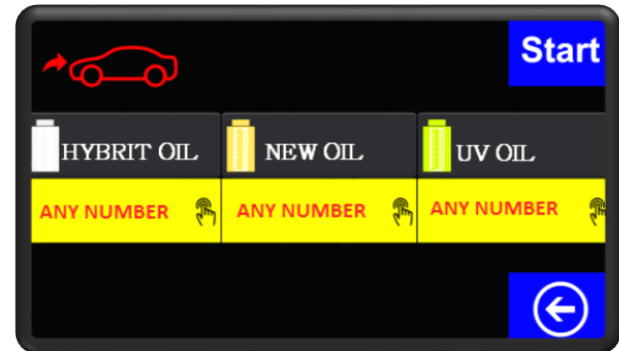
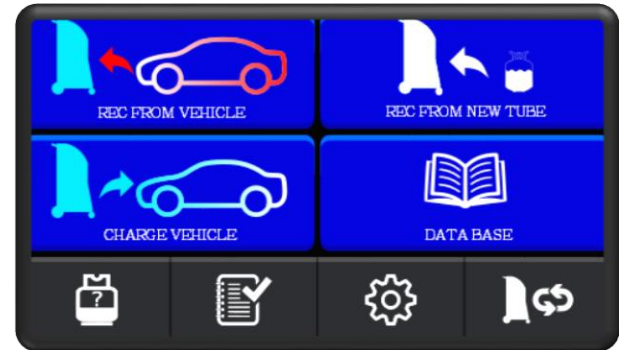

➤ VACUUM TIME

The purpose of this process is to remove the air, water vapor and other non-condensable gases from the air conditioning system for better efficiency.

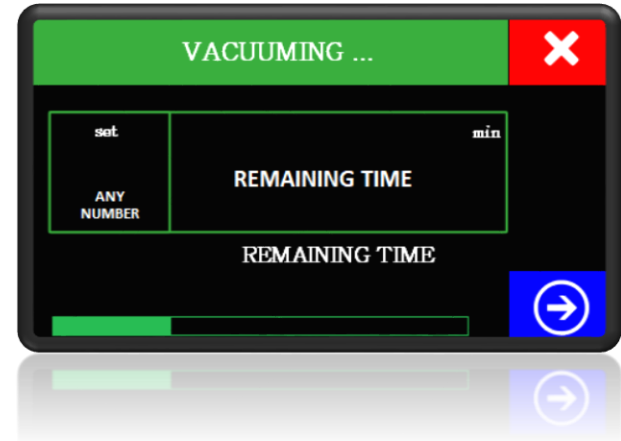

➤ LEAK CONTROL

The purpose of this process is to see that the vacuum level does remain constant or not, if not constant that means there is leak in the system.

NOTE: Vacuum operation is required before Leak Control.

1. Screen will display LEAK CONTROL TIME.
2. To skip leak control process, set the time of this section as zero.
3. Device will stop the operation Automatically and displays LEAK IN SYSTEM in case of a leakage.
4. If there is no leakage in the system, the operation will be completed and the screen on the side will be displayed.

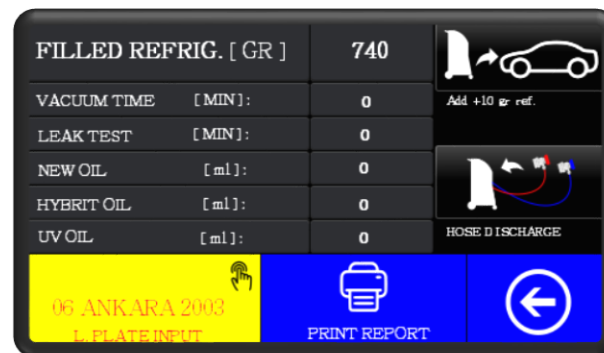
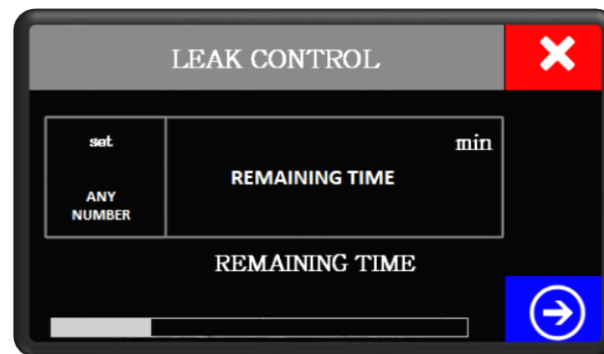

➤ REFRIGERANT

The purpose of this process is to enter the amount of gas which you want to apply to system.

NOTE: In order to get better results we have to add gas; for 180 cm add 30 gr., for 250 cm add 40 gr, for 300 cm add 50 gr. hoses difference to the amount of gas we want to add to system.

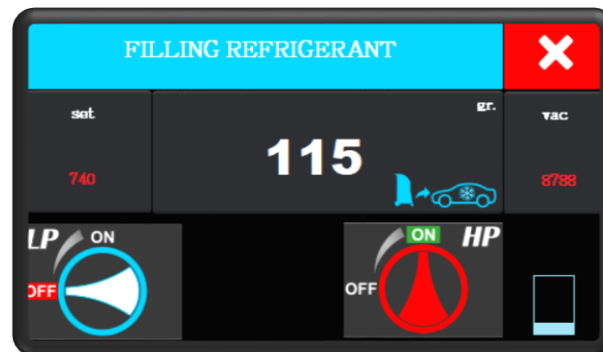

FILLING OILS

The purpose of this operation is adding hybrid oil for hybrid cars or New oil for non-hybrid cars and UV oil to find leak easily. Using UV oil is optional.

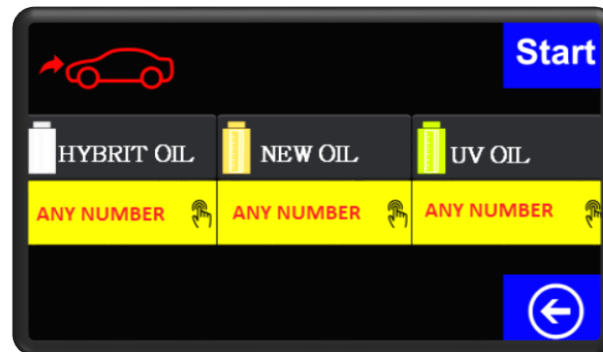

DATABASE: In this icon, the gas charging process will done automatically.

1. Select DATA BASE

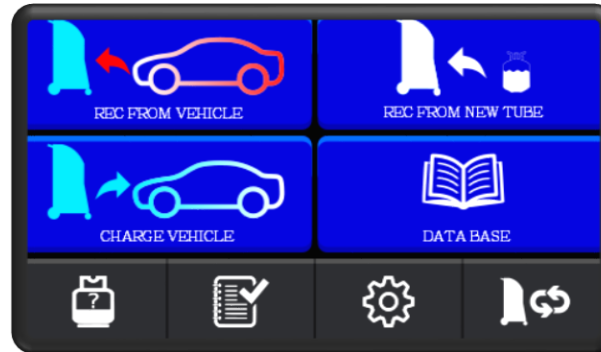

2. Select Brand, Model and year of vehicle



3. Insert required amount of wanted oils

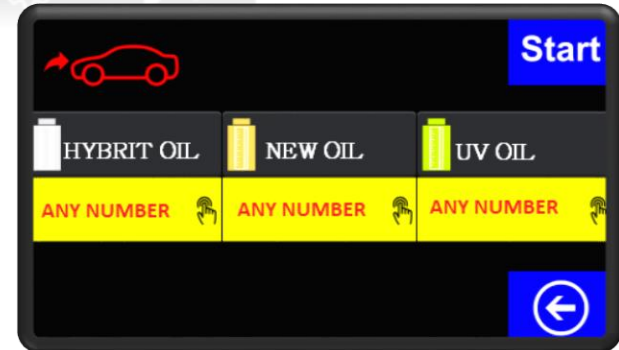

4. Vacuuming (automatic time selection)

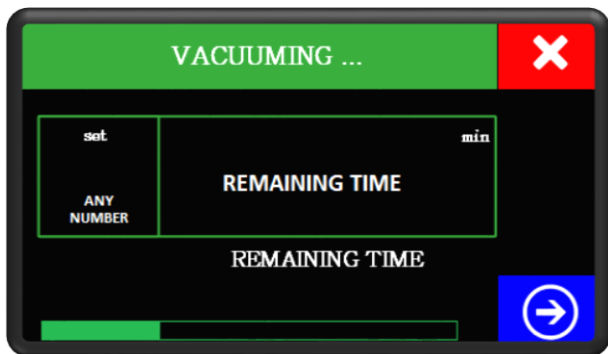

5. Leak control (automatic time selection)



6. Filling Refrigerant (automatic gas amount)

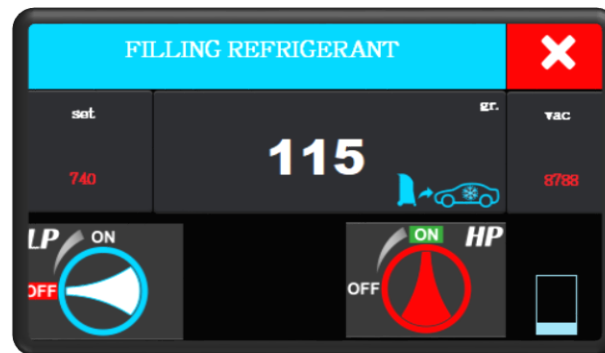

7. At the end of process will displayed.

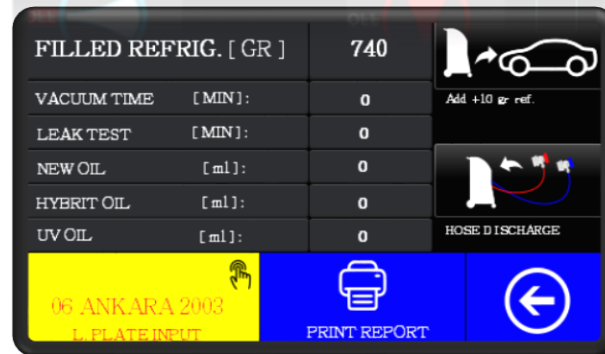

REC FROM NEW TUBE

Add refrigerant to device tank from external tank.

WARNING: Do not fill the tank completely.

WARNING: Turn external tank upside down to speed up the process.

1. Connect any one of the service hoses to the external tank and open tank's valve.
2. Close the adaptor of the other service hose.
3. Select REC FROM NEW TUBE.
4. Insert amount of recovering gas from external tube.
5. Operation will automatically stop when the own tank is full, the external tank is empty or entered amount of gas is complete.
6. At the end of the process screen will display COMPLETED.

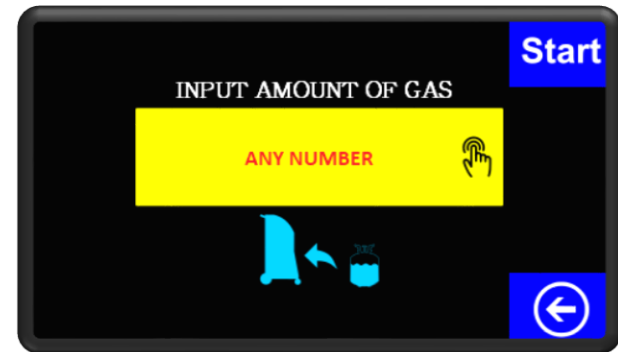

TASKBAR



CURRENT FLUIDS

STATICS

SETTING

HOSE FLUSH

CURRENT FLUIDS

In this screen there is current amount of gas in device tank, amount of new oil, UV oil and hybrid oil in each there special containers and also there is a life time of dryer filter.



STATICS

In this screen there is last recovered gas amount, Vacuum time, filter usage, gas recovered from tube and written report numbers. Total fill: total amount of filled gas to the cars Recovered: total amount of recovered gas

NOTE: Red colored digits means numbers in gram or minutes, Black colored digits means numbers in kilogram or hours.

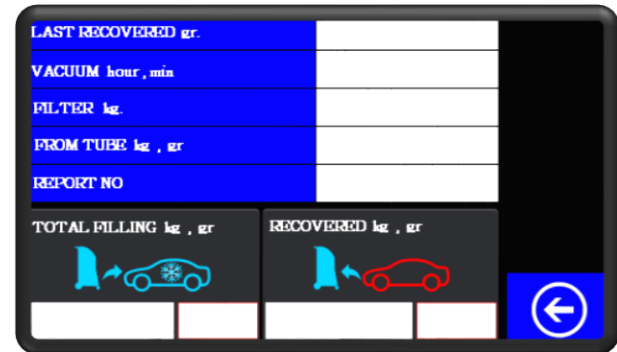

SETTING

There are many of setting and calibrations of device



DATE / TIME

To adjust the Date and Time of machine.

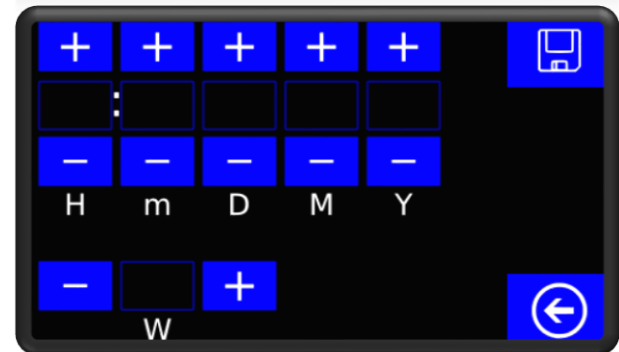

SERVIS NAME

In this part the name of servis must be written in order to know the principle of the work shop.



HOSE

In DATA BASE option there is no need to add hose difference therefore to adjust amount of gas, you must control from here. For 180 cm add 30 gr., for 250 cm add 40 gr, for 300 cm add 50 gr. hoses difference to the amount of gas we want to add to system

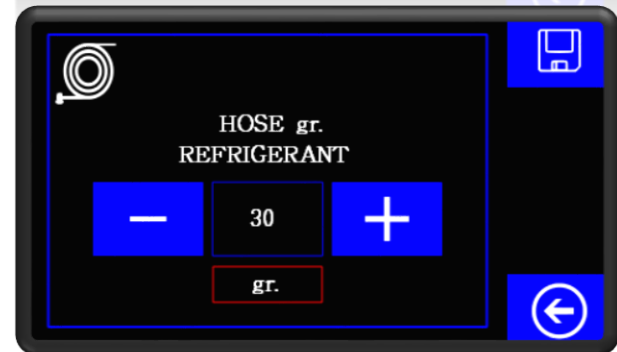

DİL - LANGUAGE

Turkish and English languages are registered in it's own memory, select the wanted language and restart the device to activate it. User's request the desired language is loaded onto.

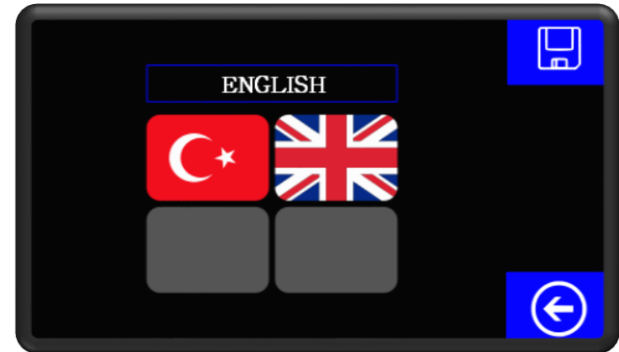

FILLING PORT

In this option you can choose filling port as you need or also you can choose automatic filling.

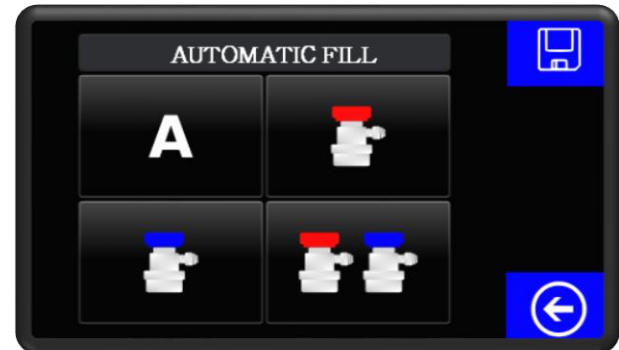

SERVICE: To enter this page and adjust calibrations you must take password from manufacturer

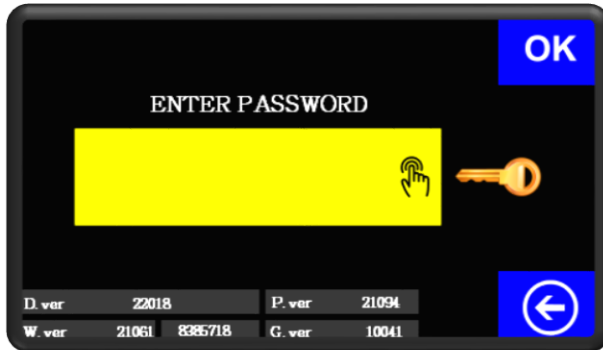

Page 1



Page 2



VACUUM PUMP OIL

In order to maintain pump efficiency, vacuum pump oil must be changed regularly. Contaminated oil might lead to irreversible damage to mechanical components of the vacuum pump. Change vacuum pump oil under the following conditions:

- Every 30 working hours or when filter drier is replaced
 - When the color of the oil becomes dark or cloudy
1. Obtain an empty container to collect the used oil.
 2. Disconnect the unit from the electrical supply.
 3. Unscrew the oil filler cap.
 4. Unscrew the drain plug.
 5. Allow the oil to drain out.
 6. Close the drain plug.
 7. Pour in new vacuum pump oil through the fill hole until mid level.
 8. Replace oil filler cap.
 9. Turn on the unit.



DRYER FILTER

Dryer filter keeps recovered refrigerant clean and moisture free. Filter must be replaced periodically in order to ensure the unit is working properly. Using full-time filters is not covered by the warranty. EKM MAX2 filters need to be replaced every 150 kg of operation. After 130 kg of operation, the unit will start reminding the user at every start up. When the filter reaches 150 kg, the unit will be locked.

1. Order a new filter.
2. Replace the filter.
3. Turn on the unit.
4. SERVICE > DRYER FILTER.
5. To complete press OK.

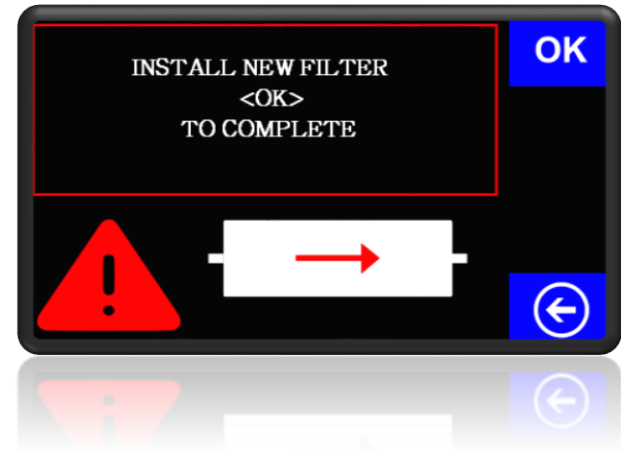

SOFTWARE UPDATE

In the beginning there is no connection.

For connecting the device

- 1- Press SOFTWARE UPDATE.
- 2- Open you mobile or tablet WiFi.
- 3- Search for ESP-----, and choose it.
- 4- Open internet adress bar and write 192.168.4.1
- 5- Press [configure WiFi](#)
- 6- Choose your WiFi name and enter password then press save.

VALVE TEST

Test all Valves, Motor and Fans. By using right and left arrows you can change the name of valves and components of the device, with pressing to ON the selected part will operate for testing.

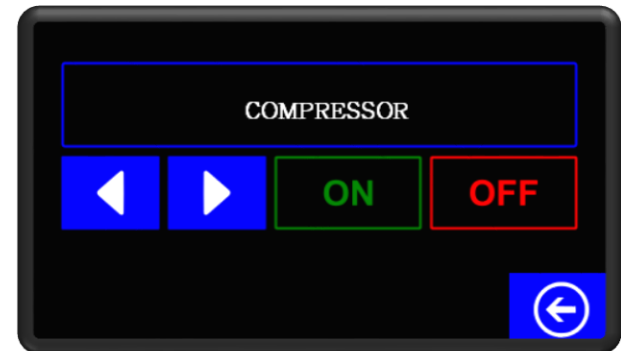

WEIGHT CALIBRATION: firstly we need an object that we know the net weight of it (min 2000 gr.).

- 1- Select weight calibration and press OK to continue
- 2- Replace the object that you know weight of it with out touching to any place or object.
- 3- Press weight calibration

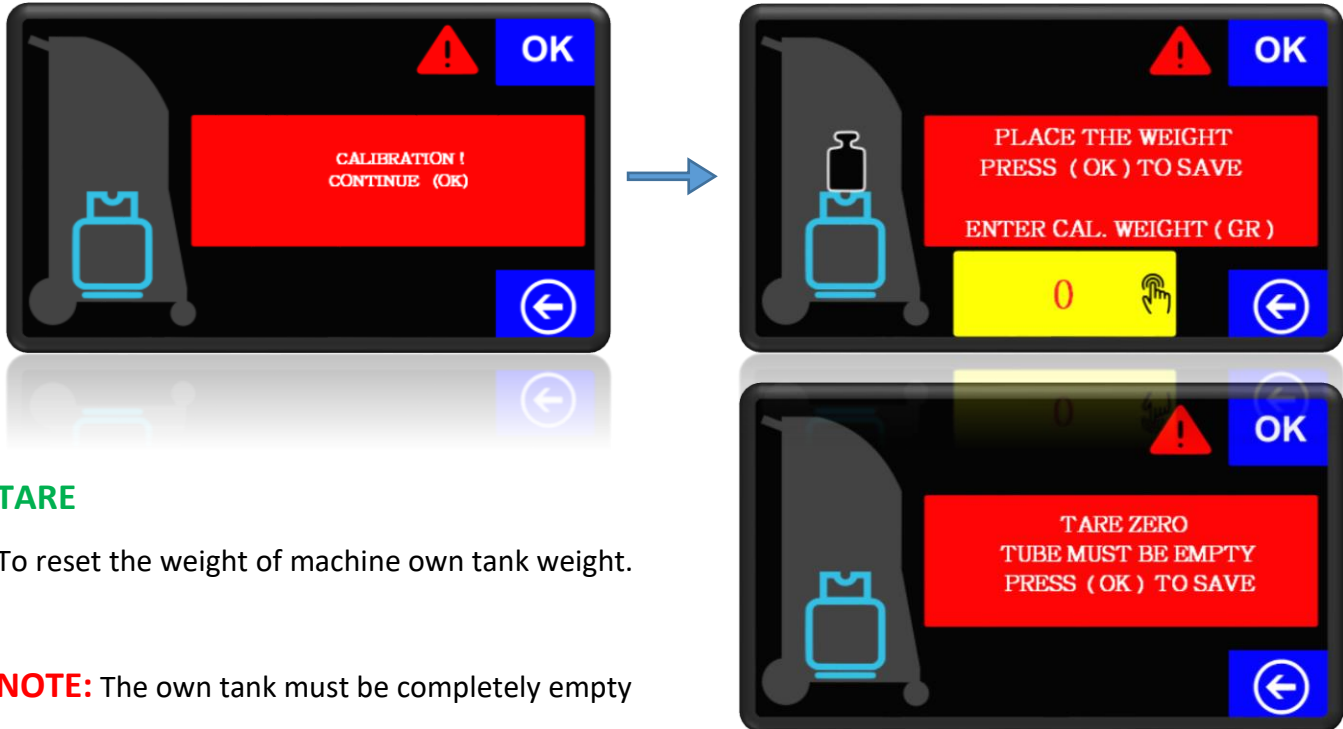

TARE

To reset the weight of machine own tank weight.

NOTE: The own tank must be completely empty

PRESSURE CALIBRATION

Select pressure calibration option



PRESSURE GAIN CAL.

To perform this operation

- 1- Replace hoses on their own place.
- 2- Charge minimum 300 gr. Refrigerant.
- 3- Note the pressure of gauges.
- 4- Select the PRESSURE GAIN option.
- 5- Insert the pressure which you noticed before.
- 6- To COMPLETE press OK.



PRESSURE ZERO CAL.

By selecting this, the pressure of machine is equalized to the atmospheric press.

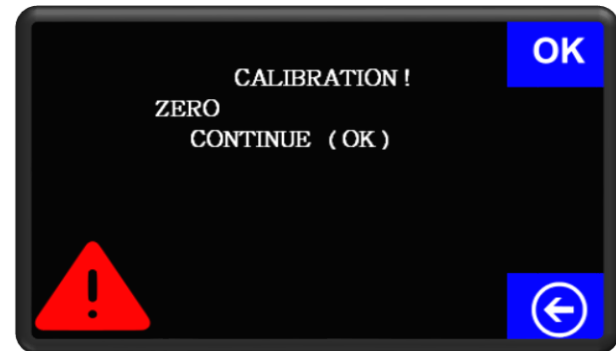

VACUUM CALIBRATION

- 1- Remove quick couplers and press OK next to it.
- 2- Replace quick couplers and press OK next to it.
- 3- The vacuum pump will start to run and counter will start counting down automatically.
- 4- After finishing the operation, screen will display COMPLETED.

WARNING: Calibration should not be done unnecessarily. If you feel that the balance is not weighing correctly, please call for technical assistance

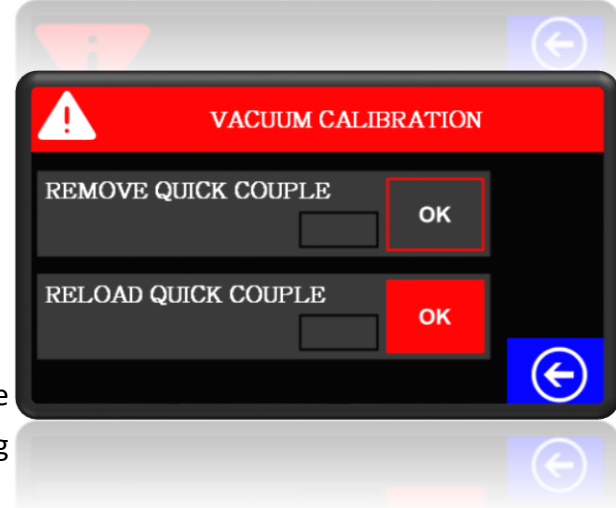

OIL CALIBRATIONS

This menu for adjust oil container Calibrations.

Cannot be done unless it is necessary.

- 1- Remove oil container from device.
- 2- Press OK below 0 ml.
- 3- Replace oil container with filling 250 ml of oil.
- 4- Press OK below 250 ml.
- 5- You can repeat this procedures to all oils.



FACTORY CALIBRATION RESET

This option is used for restore factory setting.



HOSE FLUSH

(Do this action before charging gas for hybrid cars)

This process perform to clean hoses and interior parts of Device from oils which is unsuitable for hybrid cars. Because their properties are different from each other.

1. Connect two quick couplers to machine in order to circulate flush gas in a closed circle.
2. Enter flush gas amount in gr.
3. Enter flushing time in minutes.
4. Press Start to begin the process.

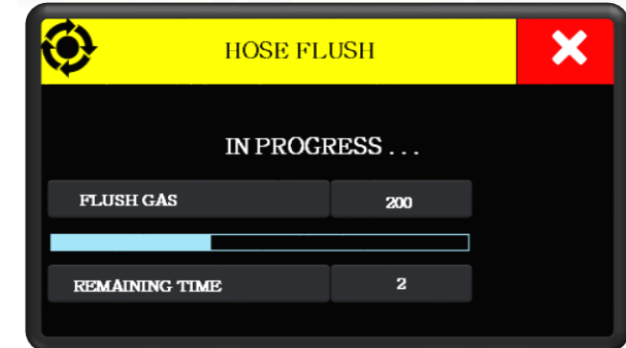

PROBLEM	CAUSE	SOLUTION	PROBLEM	CAUSE	SOLUTION	
Unit does not turn on	Power cord not plugged in	Plug in the power cord	Unit does not charge	No refrigerant in tank	Fill tank with refrigerant	
	Power switch off	Turn the power switch on		Tank valve closed	Open valve	
	Circuit breaker error	Replace circuit breaker		Service hose couplers closed	Open couplers	
	No power in AC outlet	Check power source		Service hose constricted	Straighten hose	
Unit does not recover	Manifold valve closed	Open valve		Leak in vehicle AC system	Find and repair leak	
	Service adapters closed	Open adapters		Scale calibration error	Re-calibrate scale	
	Storage tank full	Empty Storage Tank		Unit cannot pull vacuum	Loose hose connection	Tighten hose connections
	Vacuum calibration error	Re-calibrate vacuum		Leak in vehicle AC system	Find and repair leak	
Weight inaccuracies	Unit moving	Do not move unit	Oil injection valve open	Close oil injection valve		
	Storage tank touching the unit	Prevent contact	Leak in hoses	Find and repair leak		
			Contaminated vacuum pump oil	Change vacuum pump oil		

WARRANTY TERMS

1. Warranty period is (...) years and commences on the delivery date of the product.
2. The entire product except the hoses and the adapters is warranted by our company.
3. The warranty certificates without the sales date written by the seller/dealer and stamp and signature are invalid.
4. If the product becomes defective within the warranty period, the time elapsed during repair is added to the warranty period. The repair period of the product is maximum 30 (thirty) working days. This period starts as of the date the defect of the product is notified to the service station, or if a service station is not available, to any one of the product's seller, distributor, agency, representative, importer or manufacturer. If defect of the product is not remedied within 15 working days, the manufacturer and importer must allocate another industrial product with similar functions to the use of the consumer until repair of product is completed. National, legal and religious holidays and weekends are not considered as working days.
5. If the product becomes defective within its warranty period due to faults of material and workmanship or assembly, its repair shall be performed without demanding any charges as a cost of workmanship or replaced part, or by any other means.
6. Malfunctions taking place due to the use that is other than the ones stated in the operating manual of the product will not be covered under the scope of the warranty.
7. The warranty will expire automatically whenever one of the following occurs: failure to perform maintenance; **use of non-original spare parts, non recommended oils and/or gases**; use of expired filters; use of unsuitable refrigerants and/or lubricants; damage caused by shocks, fires, or other accidental events.

8. Even though the consumer uses its right of repair, if;
 - * As of the delivery date of the product to the consumer, within one year, provided that the determined warranty period is valid; the same failure recurs more than twice, or different failures occur more than four times, or total of different failures within the determined warranty period is more than six, and also if these failures prevent benefiting from the product continuously;
 - * The required maximum repair period is exceeded;
 - * It is determined that the defect cannot be remedied with a report prepared by the service station of the company, and if a service station is not available, by any one of the product's seller, distributor, agency, representative, importer or manufacturer, respectively; the consumer may request the replacement of the product free of charge, or return of the cost or a discount in the cost at the rate of defect.
9. The manufacturer declines any and all responsibility for damage to vehicles on which recovery/recycling and recharging are performed if said damage is the result of unskillful handling by the operator or of failure to observe the basic safety rules set forth in the instruction manual.
10. This warranty does not cover damage arising during transportation. The product for which repair under guarantee is requested must be shipped to the manufacturer under the customer's exclusive responsibility.
11. The manufacturer shall not be responsible for any additional costs associated with a product failure including, but not limited to, loss of work time, loss of refrigerant, cross-contamination of refrigerant, and unauthorized shipping and/or labor charges.
12. For the problems that may arise concerning the certificate of warranty, you may refer to the General Directorate for the Protection of Consumers and Competition of the Ministry of Industry and Trade.

WARRANTY CERTIFICATE

MANUFACTURING COMPANY

TITLE ELCİ ELEKTRONİK KLİMA SANAYİ VE TİCARET LTD. ŞTİ.
ADDRESS İVEDİK ORGANİZE INDUSRIAL REGION WOOD WORKING SITES
1354. ST. 1357. Qr. NO: 30 YENİMAHALLE / ANKARA / TÜRKİYE
TELEPHONE +90 312 395 53 53 (PBX)
FAX +90 312 395 18 86

PRODUCT

TYPE REFRIGERANT RECOVERY RECYCLE RECHARGE MACHINE
BRAND ELCİ
MODEL EKM MAX 2
SERIAL NUMBER
PLACE AND DATE OF DELIVERY
WARRANTY PERIOD
MAXIMUM REPAIR PERIOD 30 WORKING DAYS

DEALER OR DISTRIBUTOR COMPANY

TITLE
ADDRESS
TELEPHONE
FAX
INVOICE DATE AND NUMBER

Gases and oils recommended by the manufacturer;

Refrigerants:

- ✓ Tazetti
- ✓ Solkane
- ✓ AG Adge
- ✓ Arkema
- ✓ Honeywell
- ✓ Chemours

Compressor Oils:

- ✓ ELCI PAO Compressor Oil
- ✓ Reniso PAG
- ✓ Reniso Triton SEZ 68 POE
- ✓ Reniso Triton SE 170 POE

Vacuum Pump Oils:

- ✓ ELCI Vacuum Pump Oil
- ✓ Value Vacuum Pump Oil.

ELCI Electronic Air Conditioning Industry Trade Limited Company was founded in 2003 and has become the leader in the production of Air Conditioning Service Stations in a short time.

Since its foundation, **ELCI** had contributed to continuous development with production according to Turkish Standards and European norms.

We are awarded with ISO 9001:2008 that has the validity all around the world and CE certificate that satisfies all quality and safety requirements necessary for European Union (EU) countries.

Our customer oriented management system and continuous research and development activities enable us to offer the best price to meet the expectations of the customers at highest level, without compromising the quality. From design to after sales in every stage of production, we are contributed to Total Quality Management System.

The first full automatic recharge station in Turkey was developed and produced by **ELCI** in 2003 with a great success. And in 2013 another milestone in the company's history, is the design and production of the first recharge station operating by a tablet via Bluetooth technology. From the beginning, our experienced team dedicated to follow the technological developments to produce more user friendly products for more environmentally friendly world.



SERVICE QUALITY DOCUMENT

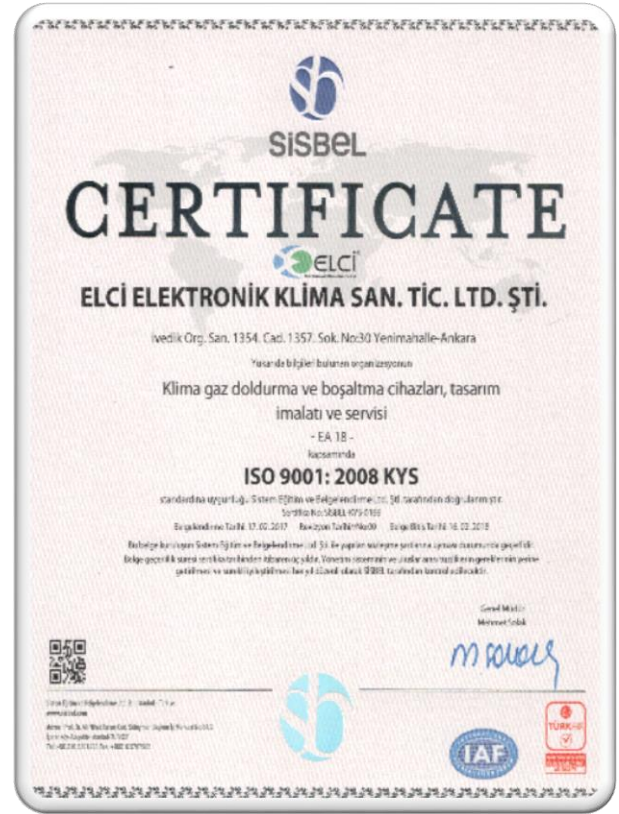

ISO 9001:2008



T.C.
TÜRK PATENT ENSTİTÜSÜ

MARKA YENİLEME BELGESİ

Marka No : 2004 06901 - Ticaret



Marka Sahibi : ELCI ELEKTRONİK KLİMA SANAYİ TİCARET LİMİTED ŞİRKETİ
TÜRKİYE CUMHURİYETİ
İVEDİK ORGANİZE SAN. 1354.CAD.1357.SOK. NO:30
OSTİM YENİMAHALLE ANKARA

Emtiası : 11
Klimasizasyon ve havalandırma cihazları.

İş bu Marka ilk defa 17/03/2004 tarihinde tescil edilmiş olup, 556 Sayılı Markaların Korunması Hakkında Kanun Hükmünde Kararname ile 40. Maddesi gereğince 17/03/2014 tarihinden itibaren ON YIL süreyle yenilenmiştir.

F.H.B. AKIN
Enstitü Başkanı
Markalar Dairesi Başkanı
Hüseyin ÖZDEYİR
Sözcük Bilimci

TÜRK PATENT ENSTİTÜSÜ



AT DECLARATION OF CONFORMITY

ELCI ELEKTRONİK

73/23/AT Low Voltage Directive
Manufacturer : ELCI Elektronik Klima San. Tic. Ltd. Şti.

Address : İvedik Organize Industrial zone wood work industrial 1354. Road. 1357. Cr. No 30 Ostim/ANKARA
Telephone : +90 312. 395 53 53
Fax : +90.312. 395 18 86

Elci elektronik described the device below;

Description : Air-conditioner gas filling in vehicles, are numerically controlled mobile devices produced for gas exchange.

Product group : Air-Conditioner gas filling device for vehicles
Type : EKM 3000
Serial No : _____
Prod. Date : _____

73/23/AT According to the requirements of the Low Voltage Directive and following new directive : 93/73/AT Pressure Vessel Directive , 89/336/AT Electromagnetic Compatibility Directive and declares that it has designed and manufactured conformity with these requirements in accordance with the harmonized standards set out below.

İmzalayan : Ahmet Kaşka
Yer : Ankara / TÜRKİYE
Görevi : General Manager
Tarih : _____
İmza : _____

BRAND RENEWAL CERTIFICATE

CE DECLARATION OF CONFORMITY

